

Wall Mounted Ironing Board



【PRODUCT NAME】

Wall Mounted Ironing Board

【SKU】

33. 35. 30100200

【PRODUCT DESCRIPTION】

This wall-mounted ironing board can be rotated 180° horizontally with double folding for easy storage. It is suitable for homes or hotel bedrooms with dedicated ironing rooms.

DESIGN CONCEPT

Limited space is the main reason why users avoid purchasing standard ironing boards. Most traditional ironing boards are X-shaped, consisting of steel pipes, brackets and boards. We need to unfold the ironing board when ironing clothes, and put it away after ironing. It can not be more annoying to iron clothes in a narrow space when children are playing around. Therefore, Venace designed this 180° wall mounted ironing board to solve this problem perfectly.

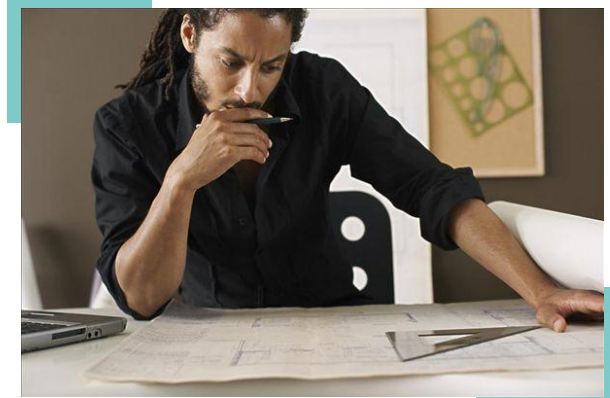

PRODUCT FEATURES

- :: Wall-mounted installation: thick white painted steels are used, which are not easy to damage, and safe with strong load-bearing capacity.
- :: Delicate white coating, which will not be exposed to rust in long-term use, so to ensure a safe and pleasing ironing.
- :: Double-layer foldable and 180 degrees rotatable design make it convenient to iron clothes and put the ironing board away.
- :: Removable flame retardant cotton cover: easy to clean.
- :: Suitable for homes and hotel bedrooms with ironing rooms.



PRODUCT SPECIFICATIONS

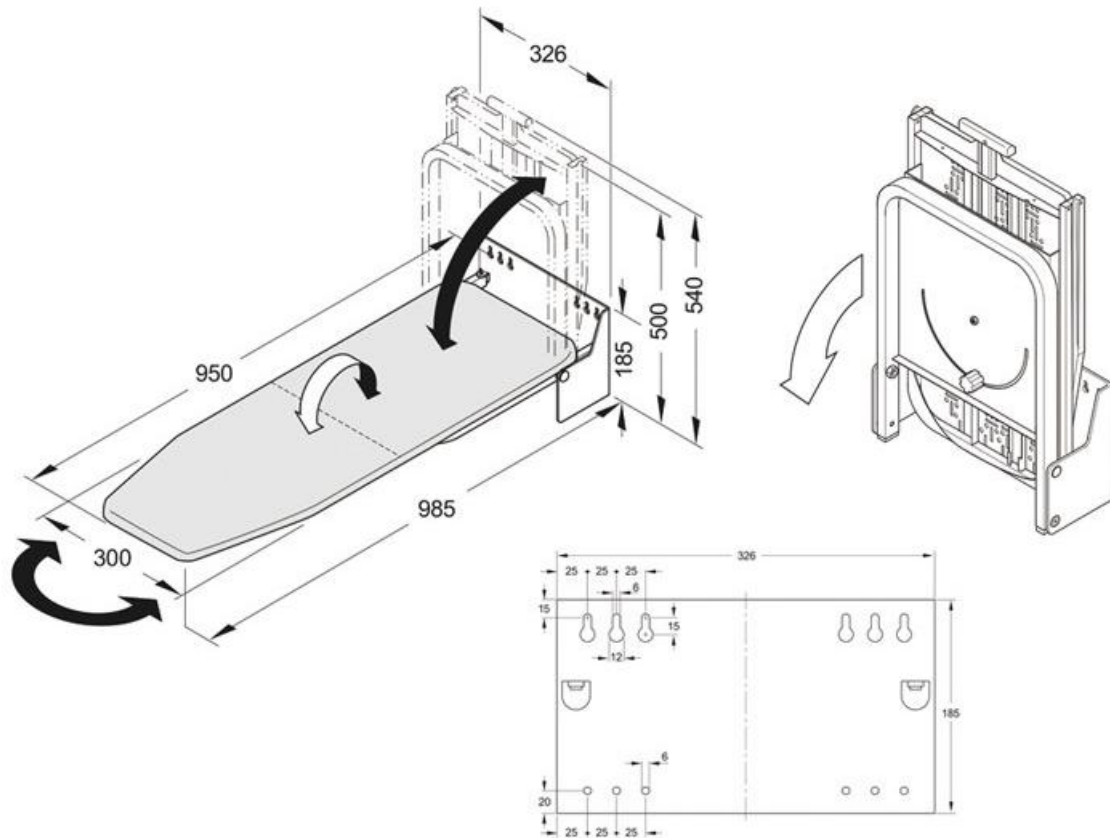

Type	Rotatable and foldable type	Product Size (mm)	L985 * W300 * H185 mm (unfolded)
Rotation Angle	180° horizontally	Net Weight (kg)	8.25
Material	Frame: Steel Cover: High temperature resistant / flame retardant cotton	Board Length (mm)	950
Color	White cotton with gray stripes	Package Size (mm)	L540 * W345 * H150
Load Capacity	10-15 kg	Gross Weight (kg)	8.9

NOTES FOR ORDERING

:: The wall-mounted board should be installed on the wall with a thickness of more than 55 mm. Please order a wooden board to thicken the wall if the thickness is not enough.

:: The standard product includes a high-temperature resistant cotton cover. Please specify if a flame retardant cover needs to be customized.



NOTES FOR ORDERING

:: The wall-mounted board should be installed on the wall with a thickness of more than 55 mm. Please order a wooden board to thicken the wall if the thickness is not enough.

:: The standard product includes a high-temperature resistant cotton cover. Please specify if a flame retardant cover needs to be customized.



INSTALLATION GUIDE

Install Into Reinforced wall only.
Do NOT INSTALL DIRECTLY INTO DRYWALL

Material and Tools:



Electric drill



Oily pen



3" screw*6pcs

Step 1

Hold Ironing board base in place in the desired location and mark The top 4 Holes and the bottom 2 holes (this step requires 2 people)

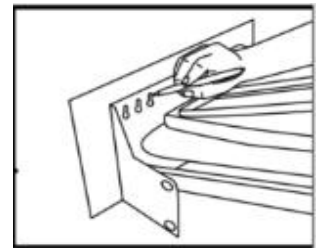

Step 2

Drill the 4 top crews into the marked spots 3/4 of the way in, mount The ironing board then finish screwing in the screws.

Step 3

Install screws into the holes on the bottom of the Ironing board Base..

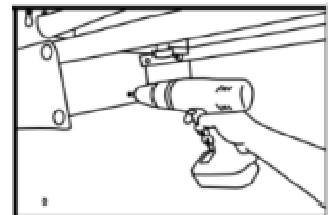



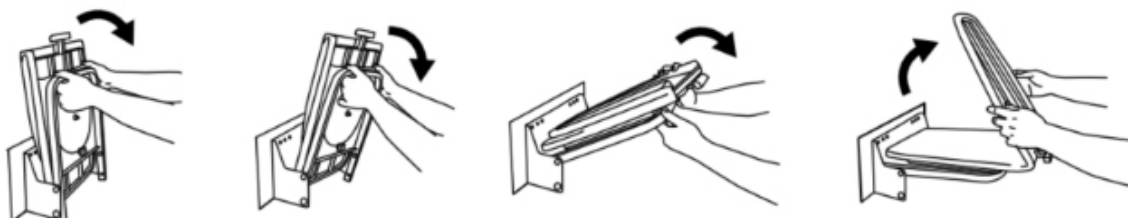

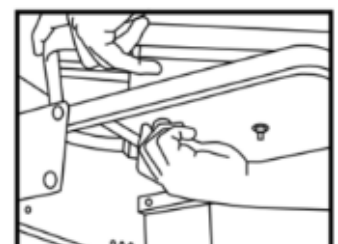

Fold and unfold the board as below:



Loose the wheel under the ironing board to rotate The board and tighten to lock the board in place.



PACKLING LIST

No.	Parts	Picture	Quantity
1	Striped Cotton Cover		1
2	180° Ironing Board		1
3	m5*50 Stainless Steel Screw		6
4	40*8 Plastic Wall Plug		6
5	Plastic Packaging Bag		1
6	Pearl Cotton Board		1
7	Instruction		1

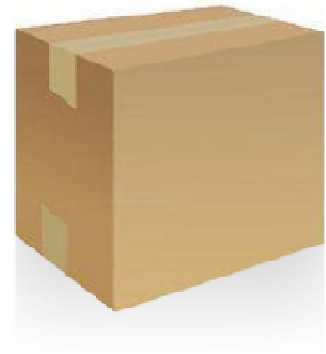

SHIPPING INFORMATION

SKU	Sets/ CTN	Net Weight/ CTN (kg)	Gross Weight/ CTN (kg)	Package Size (mm)	Sets/ 20 GP	Sets/ 40 GP	Sets/ 40 HP
33.35.30100200	1	8.25	8.9	540*345*150	980	2040	2400

The above container load quantity is the reference value.

